

BAS40W/-04/-05/-06 SCHOTTKY BARRIER DIODE

FEATURES

- Low Forward Voltage
- Fast Switching

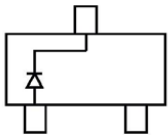

BAS40W MARKING: 43•

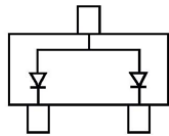

BAS40W-06 MARKING: 46

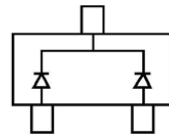

BAS40W-05 MARKING: 45

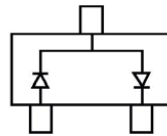

BAS40W-04 MARKING: 44

MARKING:

BAS40W	BAS40W-06	BAS40W-05	BAS40W-04

Solid dot = Green molding compound device, if none, the normal device.

Maximum Ratings @Ta=25°C

Parameter	Symbol	Limit	Unit
Peak repetitive peak reverse voltage	V_{RRM}	40	V
Working peak reverse voltage	V_{RWM}		
DC blocking voltage	V_R		
Forward continuous current	I_{FM}	200	mA
Power dissipation	P_D	150	mW
Thermal resistance junction to ambient	$R_{\theta JA}$	667	°C/W
Junction temperature	T_J	125	°C
Storage temperature range	T_{STG}	-55~+150	°C

ELECTRICAL CHARACTERISTICS (Ta=25°C unless otherwise specified)

Parameter	Symbol	Test conditions	Min	Max	Unit
Reverse breakdown voltage	$V_{(BR)}$	$I_R = 10\mu A$	40		V
Reverse voltage leakage current	I_R	$V_R = 30V$		200	nA
Forward voltage	V_F	$I_F = 1mA$ $I_F = 40mA$		380 1000	mV
Diode capacitance	C_D	$V_R = 0, f = 1MHz$		5	pF
Reverse recovery time	t_{rr}	$I_{rr} = 1mA, I_R = I_F = 10mA$ $R_L = 100\Omega$		5	ns

Typical Characteristics

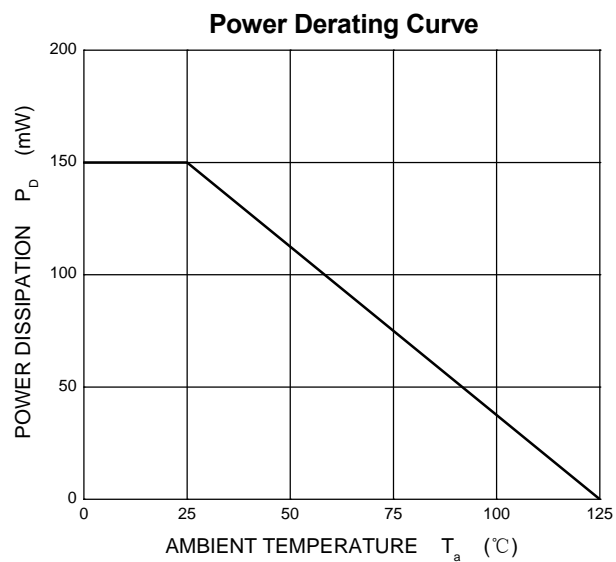
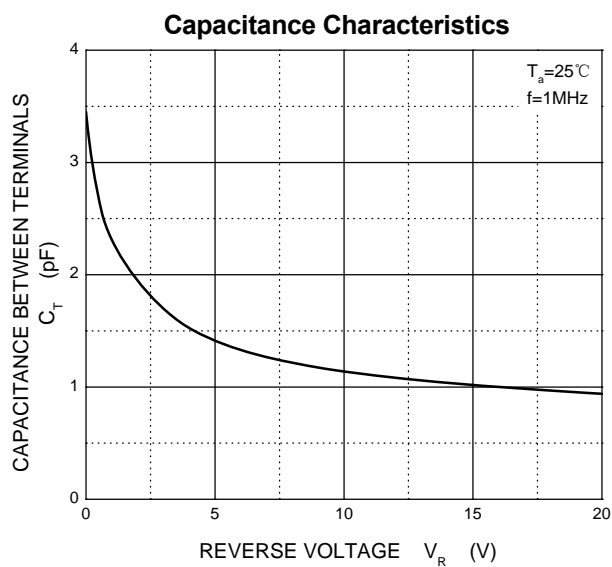
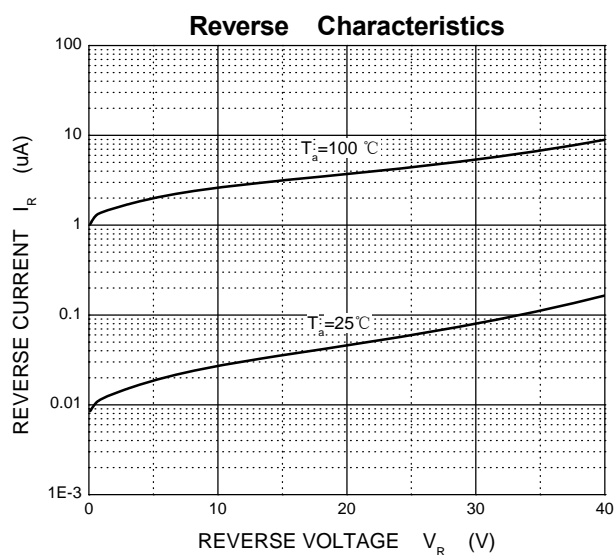
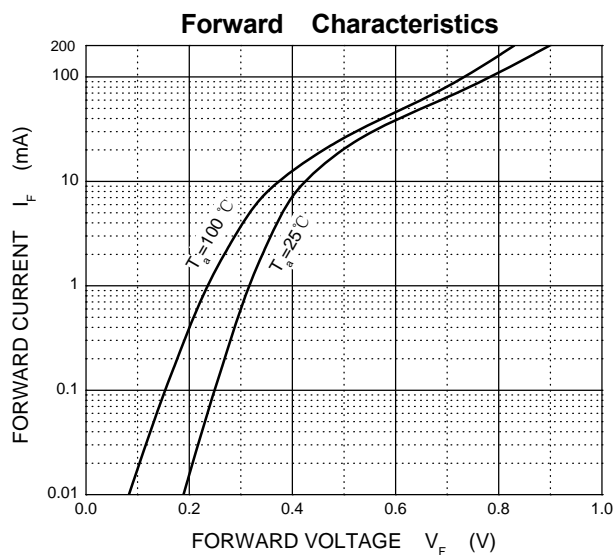

SOT-323 Package Outline Dimensions

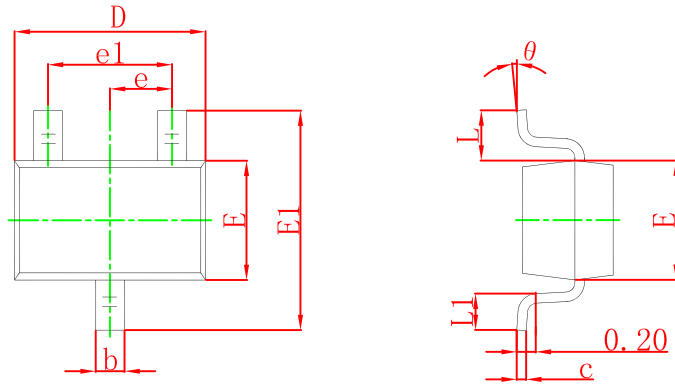

Symbol	Dimensions In Millimeters		Dimensions In Inches	
	Min	Max	Min	Max
A	0.900	1.100	0.035	0.043
A1	0.000	0.100	0.000	0.004
A2	0.900	1.000	0.035	0.039
b	0.200	0.400	0.008	0.016
c	0.080	0.150	0.003	0.006
D	2.000	2.200	0.079	0.087
E	1.150	1.350	0.045	0.053
E1	2.150	2.450	0.085	0.096
e	0.650 TYP		0.026 TYP	
e1	1.200	1.400	0.047	0.055
L	0.525 REF		0.021 REF	
L1	0.260	0.460	0.010	0.018
theta	0°	8°	0°	8°

SOT-323 Suggested Pad Layout

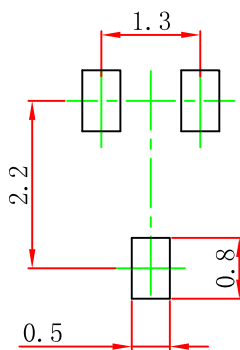

Note:

1. Controlling dimension: in millimeters.
2. General tolerance: ± 0.05 mm.
3. The pad layout is for reference purposes only.

SOT-323 Tape and Reel

SOT-323 Embossed Carrier Tape



Packaging Description:
 SOT-323 parts are shipped in tape. The carrier tape is made from a dissipative (carbon filled) polycarbonate resin. The cover tape is a multilayer film (Heat Activated Adhesive in nature) primarily composed of polyester film, adhesive layer, sealant, and anti-static sprayed agent. These reeled parts in standard option are shipped with 3,000 units per 7" or 17.8cm diameter reel. The reels are clear in color and is made of polystyrene plastic (anti-static coated).

Dimensions are in millimeter										
Pkg type	A	B	C	d	E	F	P0	P	P1	W
SOT-323	2.25	2.55	1.19	Ø1.55	1.75	3.50	4.00	4.00	2.00	8.00

SOT-323 Tape Leader and Trailer

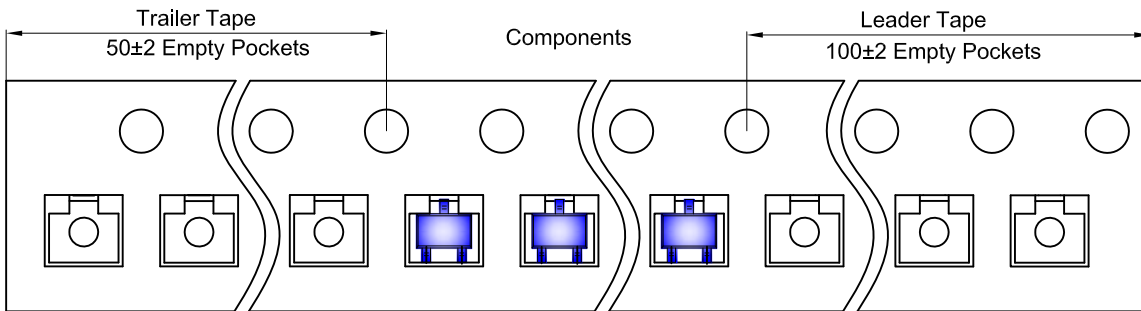

SOT-323 Reel

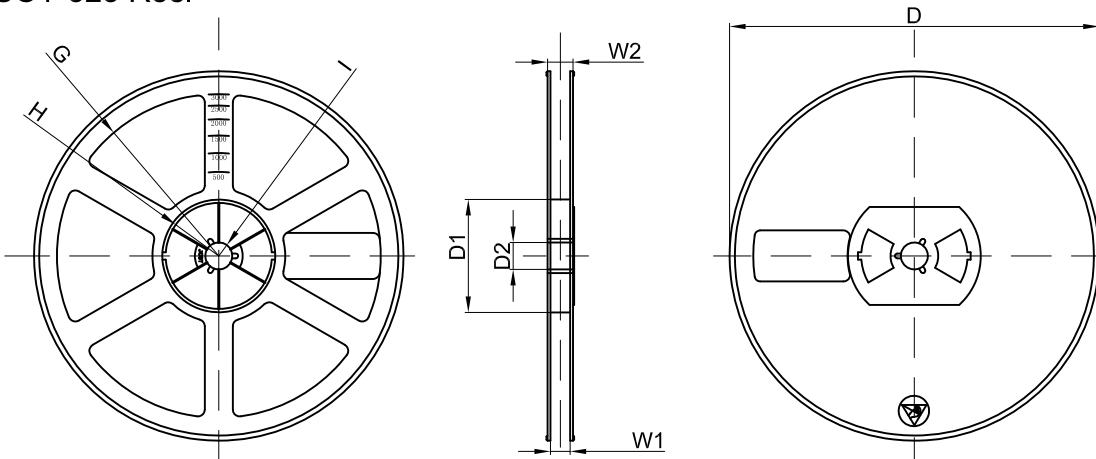

Dimensions are in millimeter								
Reel Option	D	D1	D2	G	H	I	W1	W2
7" Dia	Ø178.00	54.40	13.00	R78.00	R25.60	R6.50	9.50	12.30

REEL	Reel Size	Box	Box Size(mm)	Carton	Carton Size(mm)	G.W.(kg)
3000 pcs	7 inch	45,000 pcs	203×203×195	180,000 pcs	438×438×220	