

## 2N7002K N-channel MOSFET

$V_{(BR)DSS}$	$R_{DS(on)MAX}$	$I_D$
60V	5Ω@10V	340mA
	5.3Ω@4.5V	

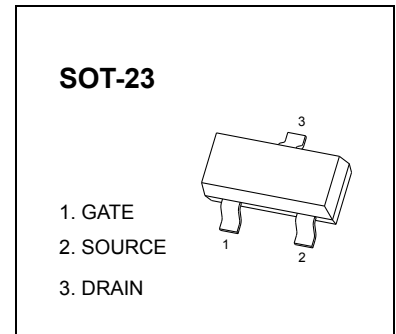

### FEATURE

- High density cell design for Low  $R_{DS(on)}$
- Voltage controlled small signal switch
- Rugged and reliable
- High saturation current capability
- ESD protected

### APPLICATION

- Load Switch for Portable Devices
- DC/DC Converter

72K

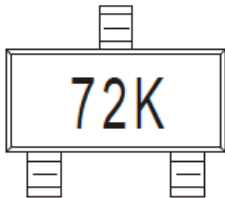

### Equivalent circuit

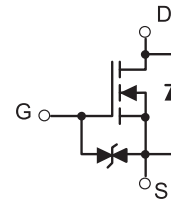

### MOSFET MAXIMUM RATINGS ( $T_a = 25^\circ\text{C}$ unless otherwise noted)

Symbol	Parameter	Value	Unit
$V_{DS}$	Drain-Source voltage	60	V
$V_{GS}$	Gate-Source voltage	±20	V
$I_D$	Drain Current	340	mA
$P_D$	Power Dissipation	0.35	W
$T_J$	Junction Temperature	150	°C
$T_{stg}$	Storage Temperature	-55~+150	°C
$R_{\theta JA}$	Thermal Resistance from Junction to Ambient	357	°C /W

## MOSFET ELECTRICAL CHARACTERISTICS

$T_a=25\text{ }^\circ\text{C}$  unless otherwise specified

Parameter	Symbol	Test Condition	Min	Typ	Max	Units
<b>Static Characteristics</b>						
Drain-Source Breakdown Voltage	$V_{DS}$	$V_{GS} = 0V, I_D = 250\mu A$	60			V
Gate Threshold Voltage*	$V_{GS(th)}$	$V_{DS} = V_{GS}, I_D = 1mA$	1	1.3	2.5	V
Zero Gate Voltage Drain Current	$I_{DSS}$	$V_{DS} = 48V, V_{GS} = 0V$			1	$\mu A$
Gate –Source leakage current	$I_{GSS1}$	$V_{GS} = \pm 20V, V_{DS} = 0V$			$\pm 10$	$\mu A$
	$I_{GSS2}$	$V_{GS} = \pm 10V, V_{DS} = 0V$			$\pm 200$	nA
	$I_{GSS3}$	$V_{GS} = \pm 5V, V_{DS} = 0V$			$\pm 100$	nA
Drain-Source On-Resistance*	$R_{DS(on)}$	$V_{GS} = 4.5V, I_D = 200mA$		1.1	5.3	$\Omega$
		$V_{GS} = 10V, I_D = 500mA$		0.9	5	$\Omega$
Diode Forward Voltage	$V_{SD}$	$V_{GS} = 0V, I_S = 300mA$			1.5	V
Recovered charge	$Q_r$	$V_{GS} = 0V, I_S = 300mA, V_R = 25V,$ $di_S/dt = -100A/\mu S$		30		nC
<b>Dynamic Characteristics**</b>						
Input Capacitance	$C_{iss}$	$V_{DS} = 10V, V_{GS} = 0V, f = 1MHz$			40	pF
Output Capacitance	$C_{oss}$				30	pF
Reverse Transfer Capacitance	$C_{rss}$				10	pF
<b>Switching Characteristics**</b>						
Turn-On Delay Time	$t_{d(on)}$	$V_{GS} = 10V, V_{DD} = 50V, R_G = 50\Omega,$ $R_{GS} = 50\Omega, R_L = 250\Omega$			10	ns
Turn-Off Delay Time	$t_{d(off)}$				15	ns
Reverse recovery Time	$t_{rr}$	$V_{GS} = 0V, I_S = 300mA, V_R = 25V,$ $di_S/dt = -100A/\mu S$		30		ns
<b>GATE-SOURCE ZENER DIODE</b>						
Gate-Source Breakdown Voltage	$BV_{GSO}$	$I_{GS} = \pm 1mA$ (Open Drain)	$\pm 21.5$		$\pm 30$	V

**Notes :**

\*Pulse Test : Pulse Width  $\leq 300\mu s$ , Duty Cycle  $\leq 2\%$ .

\*\*These parameters have no way to verify.

# Typical Characteristics

### Output Characteristics

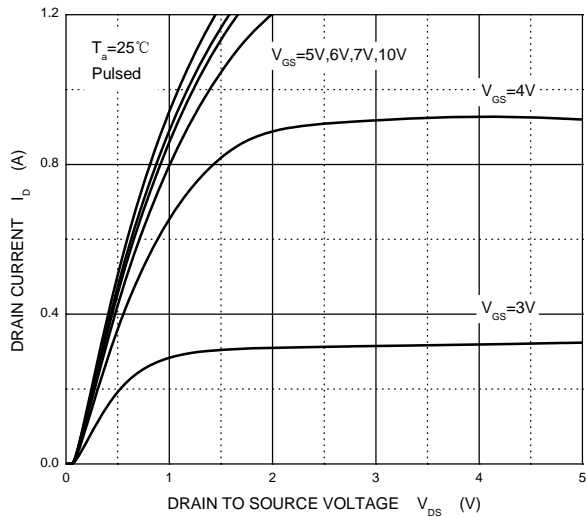

### Transfer Characteristics

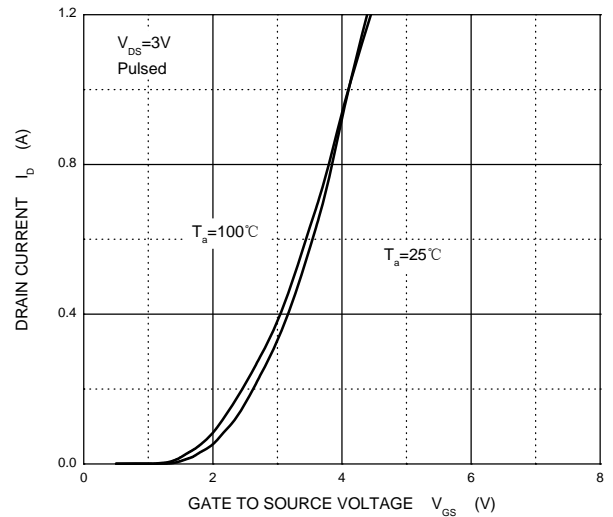

### $R_{DS(ON)}$ — $I_D$

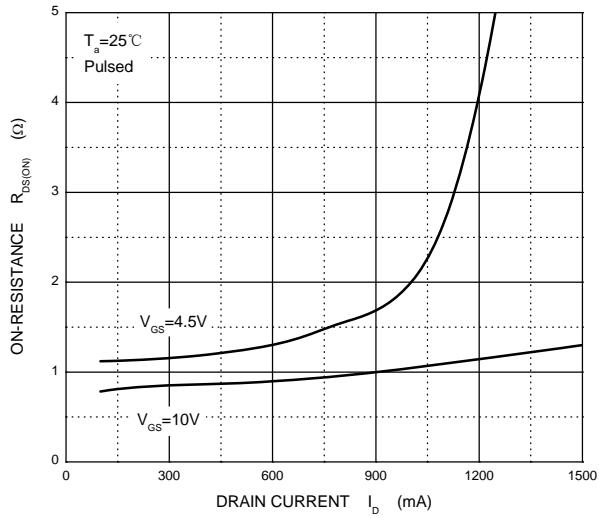

### $R_{DS(ON)}$ — $V_{GS}$

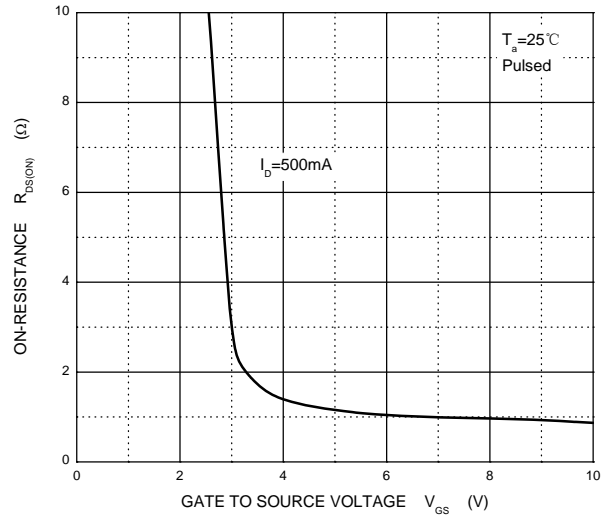

### $I_S$ — $V_{SD}$

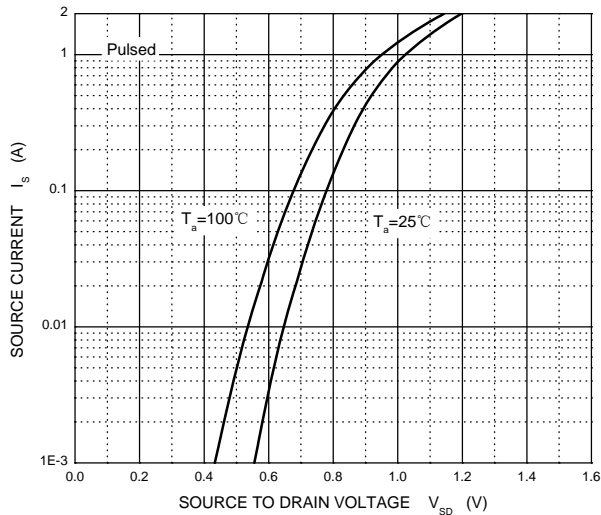

### Threshold Voltage

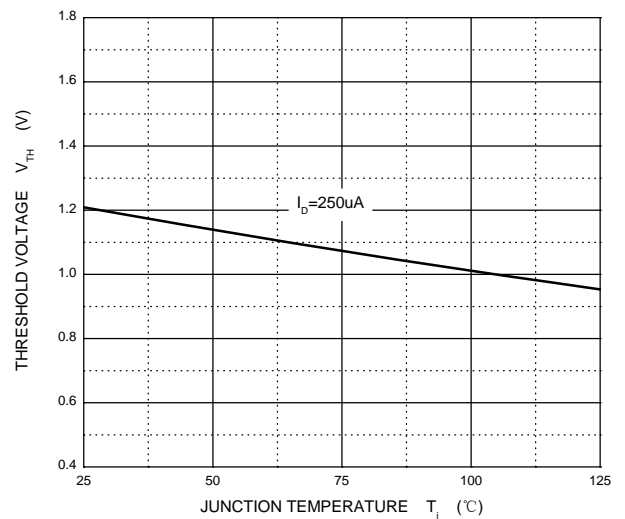

## SOT-23 Package Outline Dimensions

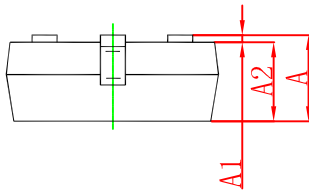
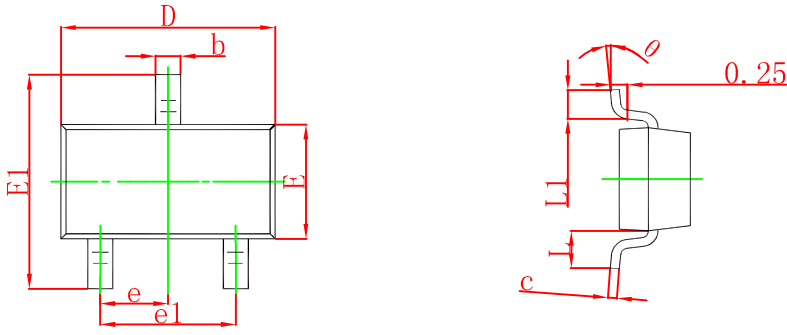

Symbol	Dimensions In Millimeters		Dimensions In Inches	
	Min	Max	Min	Max
A	0.900	1.150	0.035	0.045
A1	0.000	0.100	0.000	0.004
A2	0.900	1.050	0.035	0.041
b	0.300	0.500	0.012	0.020
c	0.080	0.150	0.003	0.006
D	2.800	3.000	0.110	0.118
E	1.200	1.400	0.047	0.055
E1	2.250	2.550	0.089	0.100
e	0.950 TYP		0.037 TYP	
e1	1.800	2.000	0.071	0.079
L	0.550 REF		0.022 REF	
L1	0.300	0.500	0.012	0.020
θ	0°	8°	0°	8°

## SOT-23 Suggested Pad Layout

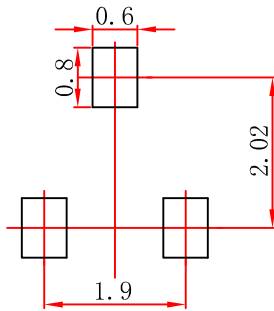

- Note:
1. Controlling dimension: in millimeters.
  2. General tolerance:  $\pm 0.05\text{mm}$ .
  3. The pad layout is for reference purposes only.

## SOT-23 Tape and reel

### SOT-23 Embossed Carrier Tape

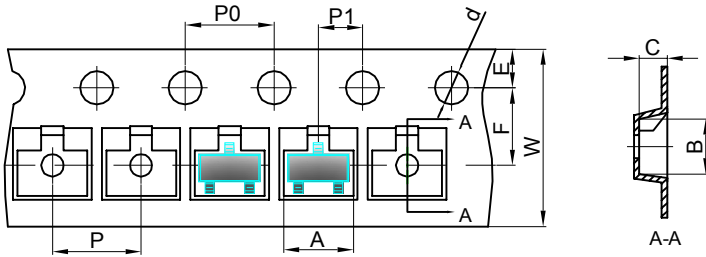

**Packaging Description:**

SOT-23 parts are shipped in tape. The carrier tape is made from a dissipative (carbon filled) polycarbonate resin. The cover tape is a multilayer film (Heat Activated Adhesive in nature) primarily composed of polyester film, adhesive layer, sealant, and anti-static sprayed agent. These reeled parts in standard option are shipped with 3,000 units per 7" or 17.8cm diameter reel. The reels are clear in color and is made of polystyrene plastic (anti-static coated).

Dimensions are in millimeter										
Pkg type	A	B	C	d	E	F	P0	P	P1	W
SOT-23	3.15	2.77	1.22	Ø1.50	1.75	3.50	4.00	4.00	2.00	8.00

### SOT-23 Tape Leader and Trailer

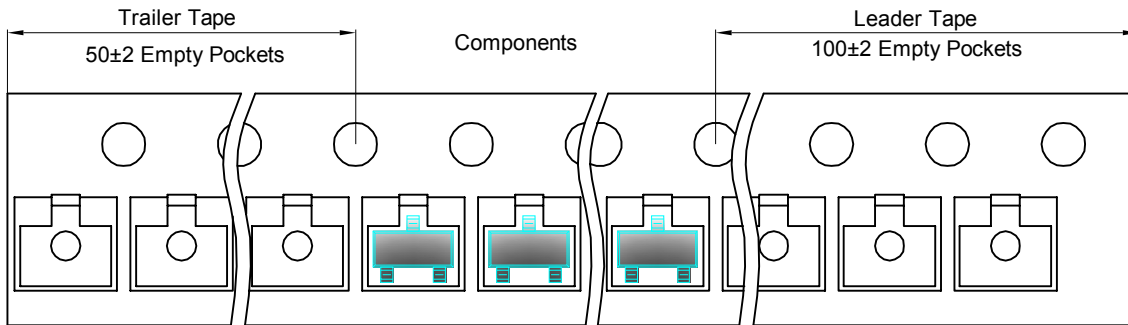

### SOT-23 Reel

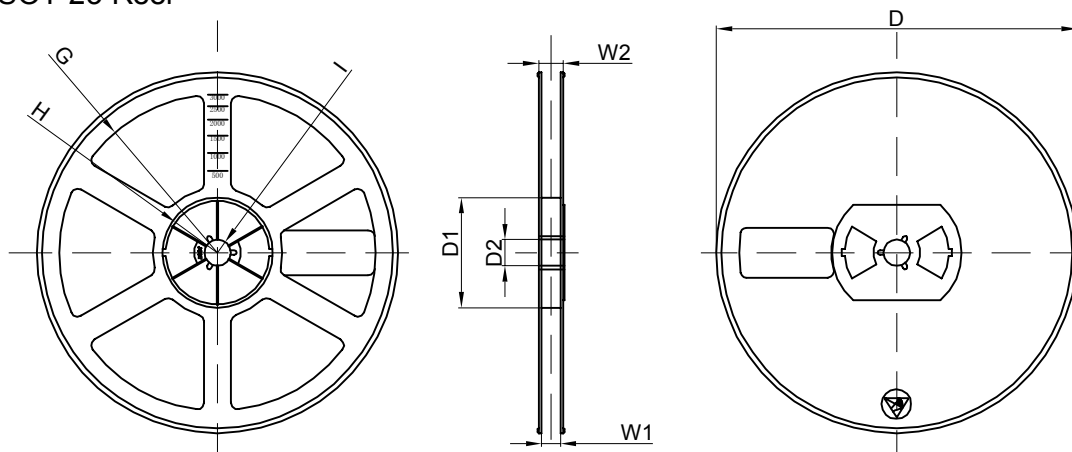

Dimensions are in millimeter								
Reel Option	D	D1	D2	G	H	I	W1	W2
7" Dia	Ø178.00	54.40	13.00	R78.00	R25.60	R6.50	9.50	12.30

REEL	Reel Size	Box	Box Size(mm)	Carton	Carton Size(mm)	G.W.(kg)
3000 pcs	7 inch	30,000 pcs	203×203×195	120,000 pcs	438×438×220	